



NEW TOOL OF PAINLESS DENT REPAIR



*Technosaf A
Brand For Professionals*



مپت

Mobin Pishro Tajhiz Isatis Company (Techno Saf)

It is the first and largest manufacturer of modern removal equipment and repair equipment that is providing services to the auto mechanics industry of our country, Iran.

With more than ten years of brilliant experience in the production of removal tools and 30 years of experience in repairing and car body services by the connection and cooperation with successful engineers and experts in this field, this company has produced new Paintless Dent Repair (PDR), workshop and repair shop's equipment and always tries to develop itself and serve the industry and artisans in this field.

Techno Saf Device 22000

Technical Specifications

- 220 volts
- One phase
- Frequency 50
- Weight 120 kg
- 22 kW instantaneous output power (22 thousand)
- Efficiency of the device 85%





EXPLANATIONS

- ◆ REPAIRING DUBBED POINTS WITHOUT THE NEED TO OPEN AND CLOSE DIFFERENT PARTS OF CAR OR SPLITTING
- ◆ SPEED AND PROGRESS IN THE SHORTEST POSSIBLE TIME
- ◆ ABILITY TO SMOOTH ALL TYPES OF AERODYNAMIC CARS, MINIBUSES, VANS, TRUCKS, BUSES, ETC.
- ◆ ABILITY TO AIR BLASTING IN ALL PARTS OF THE BODY, EVEN THE ROOF AND HOOD WITHOUT AIR AND GAS INTERFERENCE (ELECTRIC ARC)
- ◆ REPAIRING WITHOUT STRIKING, AT LEAST 80% REDUCTION
- ◆ LOW ENERGY CONSUMPTION, REDUCED WEIGHT AND DIMENSIONS
- ◆ REDUCED PHYSICAL FACTOR, HIGH SPEED AND EFFICIENCY
- ◆ USE OF ONE PHASE ELECTRICITY
- ◆ ONE-WAY AND TWO-WAY BOILING POINT
- ◆ ABILITY TO AIR BLASTING METAL AND ALUMINUM
- ◆



Techno Saf Device 19000

Technical Specifications

- 220 volts
- One phase
- Frequency 50
- Weight 100 kg
- 19 kW instantaneous output power (19 thousand)
- Efficiency of the device 80%



EXPLANATIONS

- ◆ REPAIRING DUBBED POINTS WITHOUT THE NEED TO OPEN AND CLOSE DIFFERENT PARTS OF CAR OR SPLITTING
- ◆ SPEED AND PROGRESS IN THE SHORTEST POSSIBLE TIME
- ◆ ABILITY TO SMOOTH ALL TYPES OF AERODYNAMIC CARS, MINIBUSES, VANS, TRUCKS, BUSES, ETC.
- ◆ ABILITY TO AIR BLASTING IN ALL PARTS OF THE BODY, EVEN THE ROOF AND HOOD WITHOUT AIR AND GAS INTERFERENCE (ELECTRIC ARC)
- ◆ REPAIRING WITHOUT STRIKING, AT LEAST 80% REDUCTION
- ◆ LOW ENERGY CONSUMPTION, REDUCED WEIGHT AND DIMENSIONS
- ◆ REDUCED PHYSICAL FACTOR, HIGH SPEED AND EFFICIENCY
- ◆ USE OF ONE PHASE ELECTRICITY
- ◆ ONE-WAY BOILING POINT
- ◆ ABILITY TO AIR BLASTING METAL AND ALUMINUM
- ◆



Techno Saf Device 18000

Technical Specifications

- 220 volts
- One phase
- Frequency 50
- Weight 95 kg
- 18 kW instantaneous output power (18 thousand)
- Efficiency of the device 75%



EXPLANATIONS

- ◆ REPAIRING DUBBED POINTS WITHOUT THE NEED TO OPEN AND CLOSE DIFFERENT PARTS OF CAR OR SPLITTING
- ◆ SPEED AND PROGRESS IN THE SHORTEST POSSIBLE TIME
- ◆ ABILITY TO SMOOTH ALL TYPES OF AERODYNAMIC CARS, MINIBUSES, VANS, TRUCKS, BUSES, ETC.
- ◆ ABILITY TO AIR BLASTING IN ALL PARTS OF THE BODY, EVEN THE ROOF AND HOOD WITHOUT AIR AND GAS INTERFERENCE (ELECTRIC ARC)
- ◆ REPAIRING WITHOUT STRIKING, AT LEAST 80% REDUCTION
- ◆ LOW ENERGY CONSUMPTION, REDUCED WEIGHT AND DIMENSIONS
- ◆ REDUCED PHYSICAL FACTOR, HIGH SPEED AND EFFICIENCY
- ◆ USE OF ONE PHASE ELECTRICITY
- ◆ ONE-WAY BOILING POINT
- ◆ ABILITY TO AIR BLASTING METAL AND ALUMINUM
- ◆

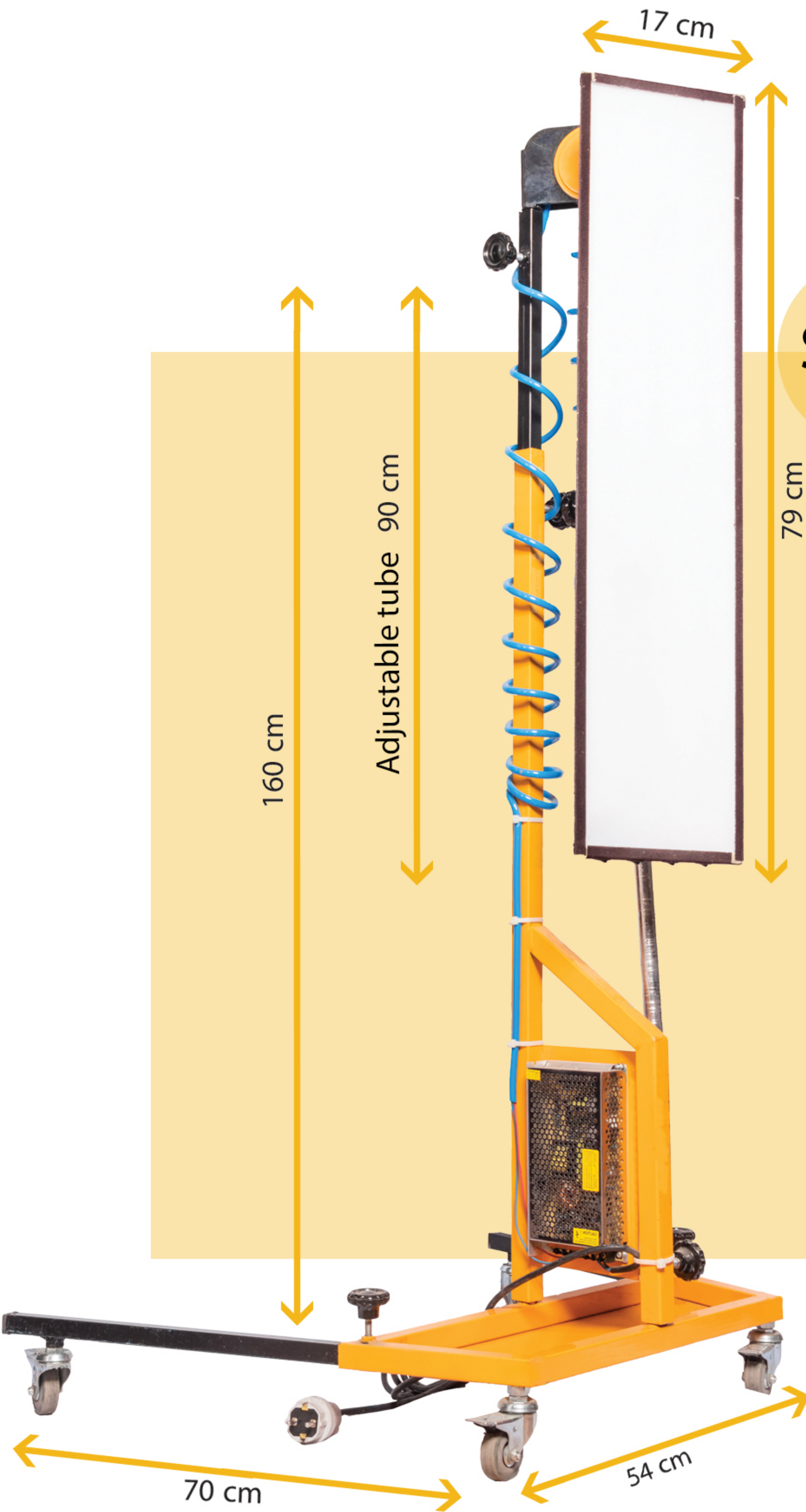

Slatted Lamp Board

Technical Specifications

- 220 volts
- One phase
- Frequency 50
- Electric current 5 amps
- Input power 70 watts
- Output power 60 watts
- Ultra-low consumption
- Efficiency 90
- Four separate lines
- Weight 15 kg

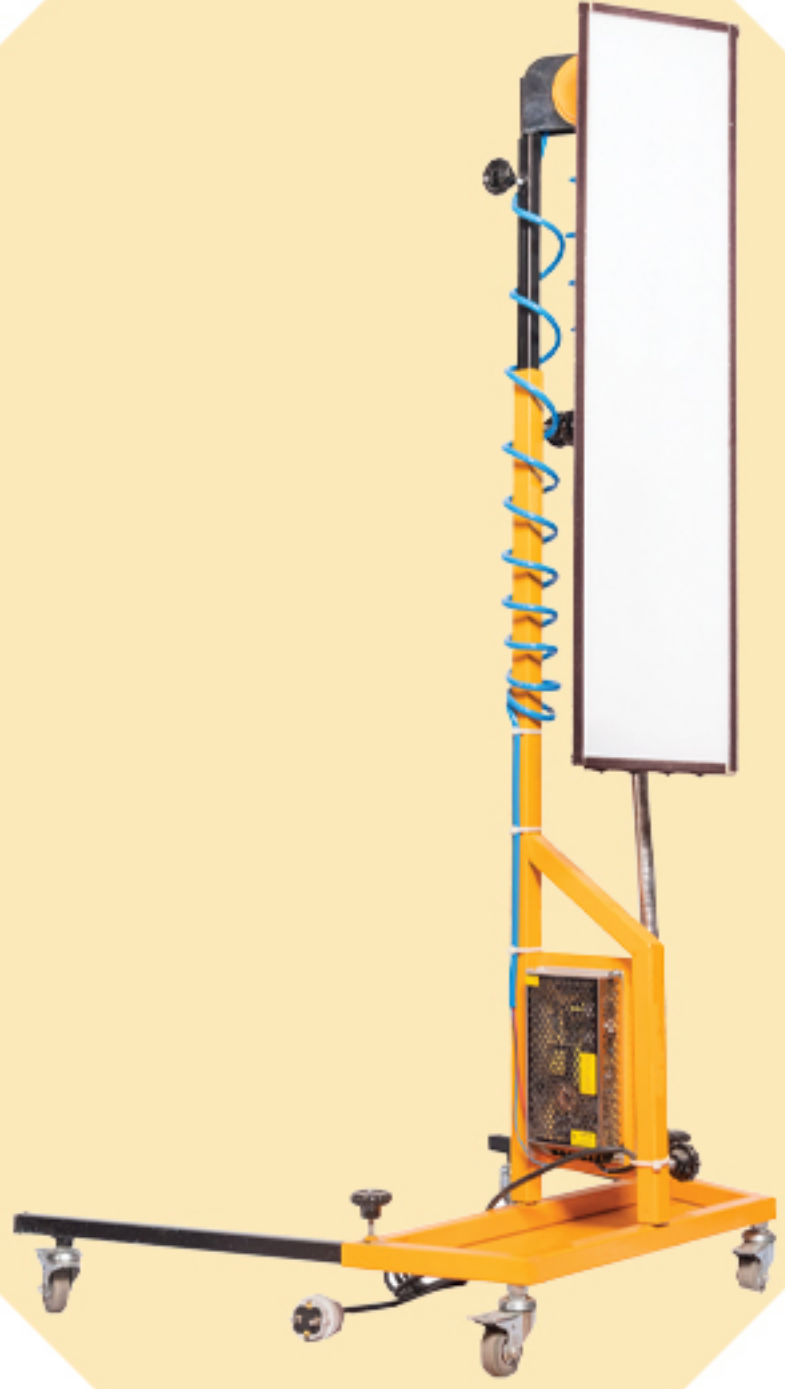

EXPLANATION

- ◆ SUITABLE FOR SEEING ALL KINDS OF SPOTS, STREAKS AND DENTS ON THE CAR BODY.

- ◆ NO NEED FOR A DARKROOM

- ◆ IT IS BETTER FOR NIGHT SIGHT THAN LAMP LIGHT AND WORKS BETTER THAN SUNLIGHT.

- ◆ CAPABILITY OF ADJUSTING LIGHT

- ◆ FOUR LINES SUITABLE FOR DARK AND LIGHT COLORS

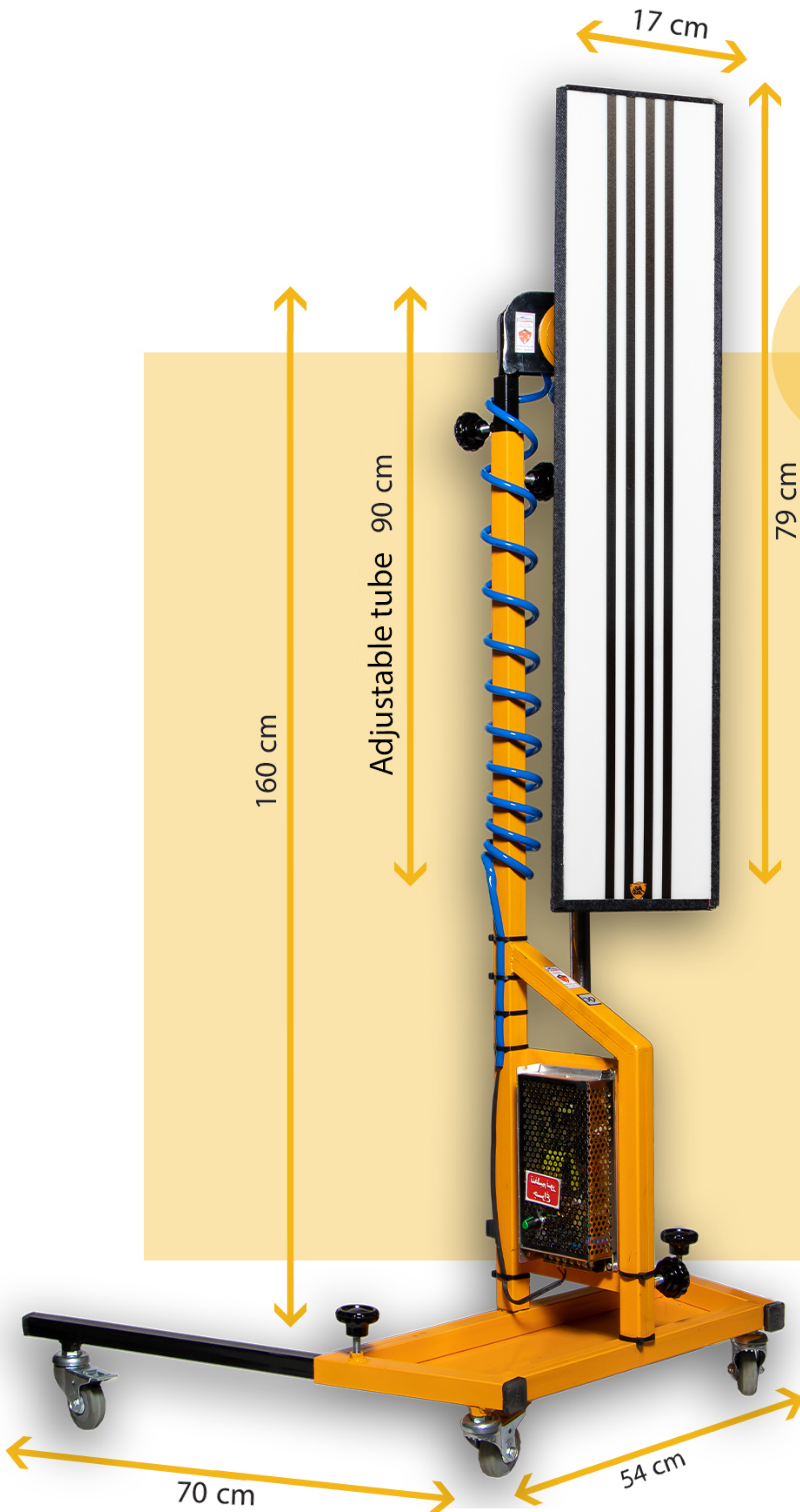

Linear Lamp Board

Technical Specifications

- 220 volts
- One phase
- Frequency 50
- Electric current 5 amps
- Input power 70 watts
- Output power 60 watts
- Ultra-low consumption
- Efficiency 90
- Four separate lines
- Weight 15 kg

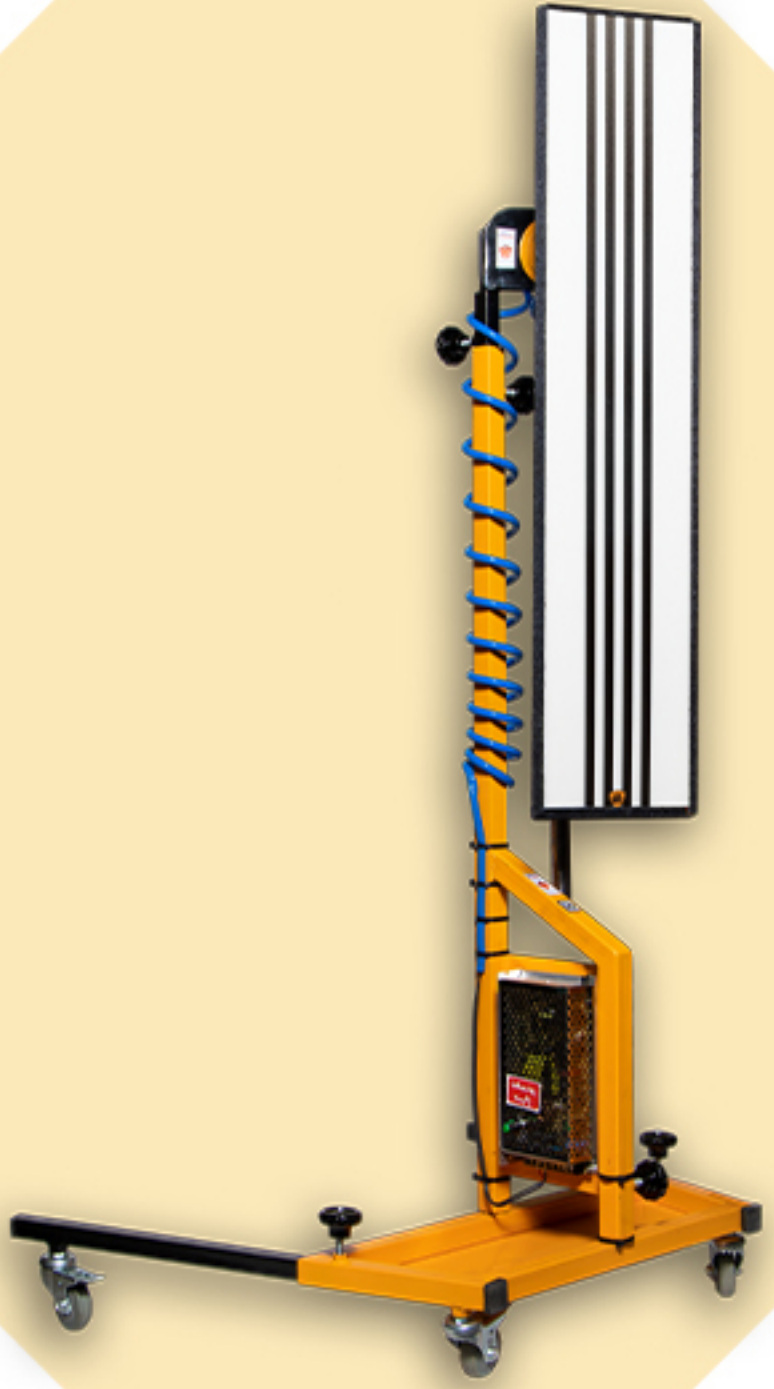

EXPLANATION

THIS BOARD IS LINEAR, AND THE LINES THAT APPEAR ON THE WORK INDICATE THE WAVES AND DENTS ON THE BODY, AND IN FACT, THIS MAKES THE WORK EASIER AND SHOWS ALL THE WEAKNESSES OF THE WORK AND MAKES THE WORK EASIER.

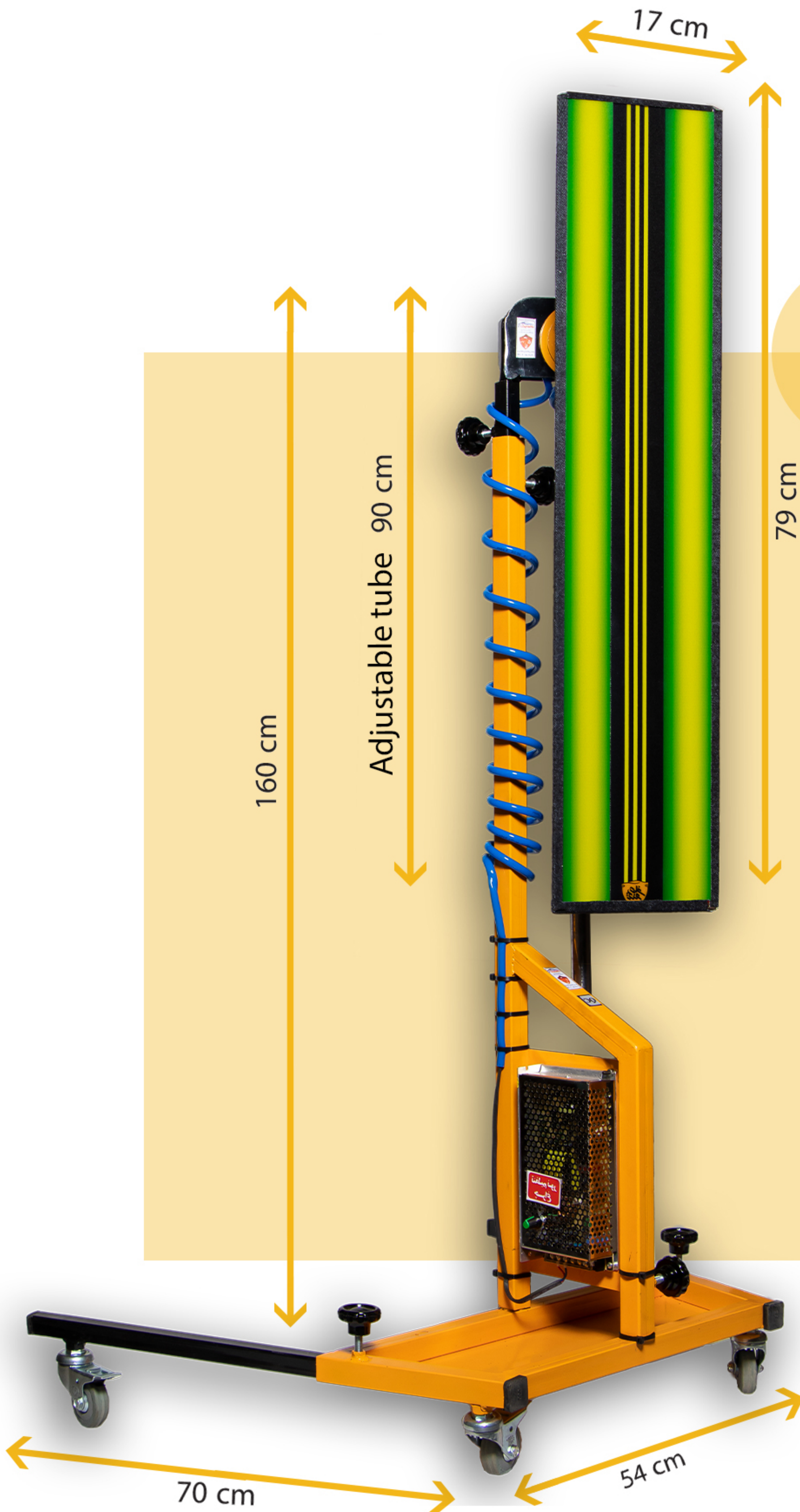

American Design Lamp Board

Technical Specifications

- 220 volts
- One phase
- Frequency 50
- Electric current 5 amps
- Input power 70 watts
- Output power 60 watts
- Ultra-low consumption
- Efficiency 90
- Four separate lines
- Weight 15 kg

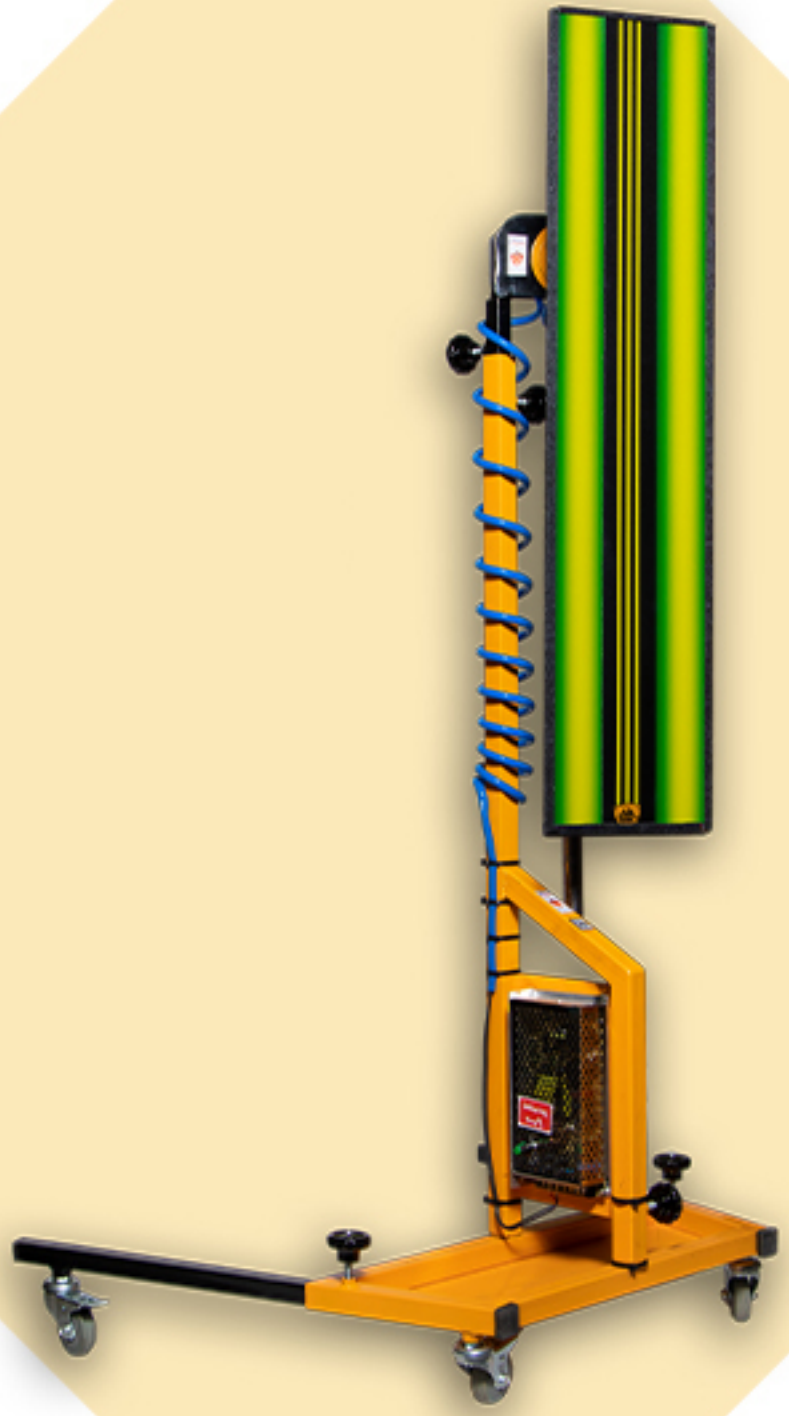

EXPLANATION

- ◆ SUITABLE FOR SHOWING A VARIETY OF STREAKS, SPOTS, AND DENTS ON THE CAR BODY, WHICH ARE LINEAR AND SLATTED.
- ◆ THE DISTINGUISH BETWEEN THIS BOARD AND THE SIMPLE PANEL, IS HOW TO USE IT. IT IS USED LINEARLY.

Air Blasting Machine

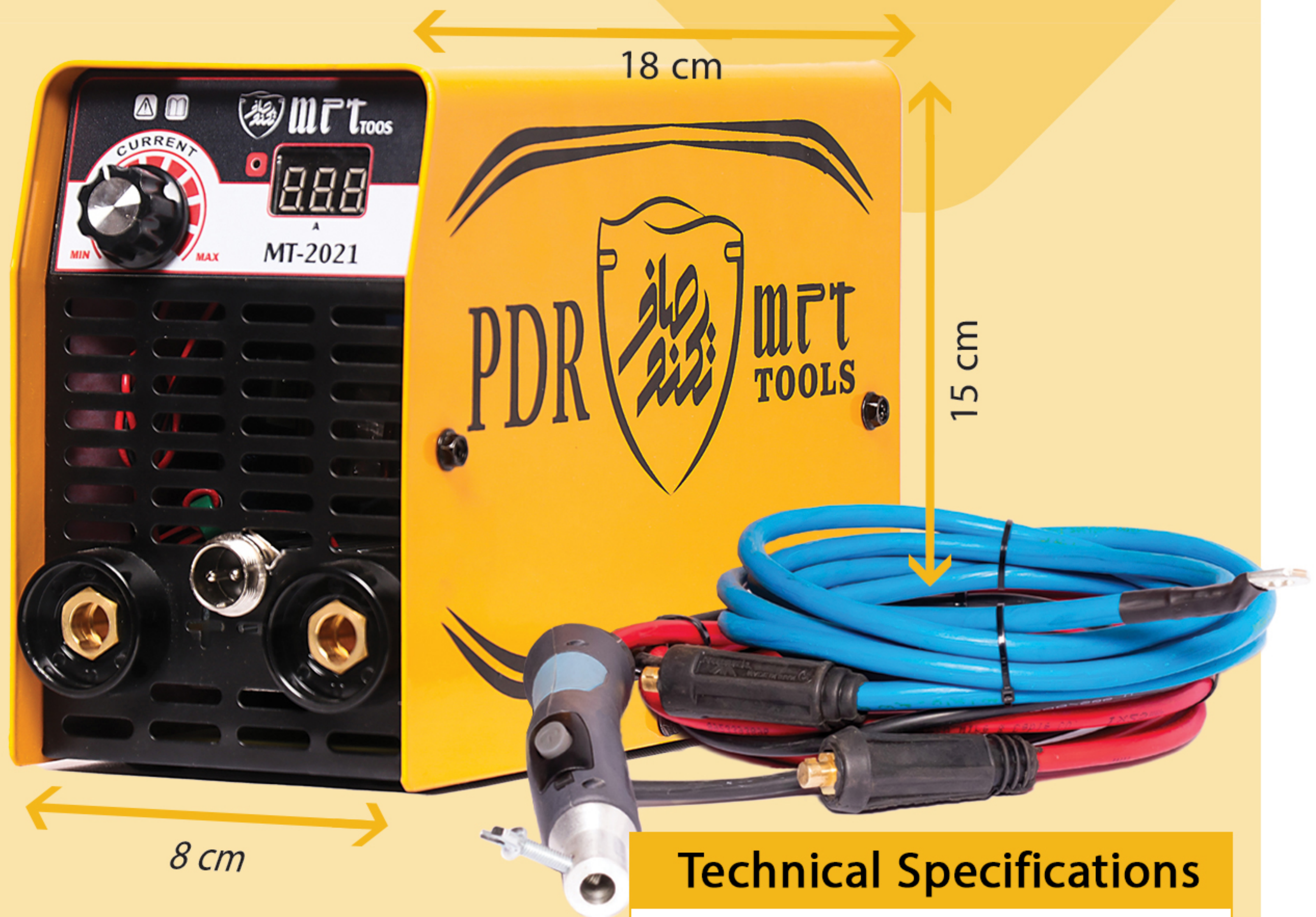

Technical Specifications

- 220 volts
- One phase
- Frequency 50
- Weight 25 kg
- Output power 700 watts
- Efficiency 60%



EXPLANATIONS

THIS MACHINE HAS THE ABILITY TO PERFORM PDR AIR BLASTING WITHOUT PAINT DISTORTION OR BURNING.

WITH THIS DEVICE, ALL KINDS OF DENTS AND STRETCHES OR SHEET STREAKS CAN BE REPAIRED IN A PAINTLESS WAY.

TECHNOSAF HOTBOX





EXPLANATIONS

THE NEWEST AND MOST MODERN REPAIRING DEVICE FOR REMOVING DENTS, DINGS, AND HAIL DAMAGES THAT WORK MAGNETICALLY AND BY INDUCING HEAT; IS THE TECHNO SAF HOTBOX MACHINE. TECHNO SAF MAGNETIC REPAIRING MACHINE IS ROBUST COMPARED TO SIMILAR SAMPLES. IT HAS ELIMINATED THE WEAKNESS OF EXTERNAL AND INTERNAL DEVICES. IT IS AN IRANIAN SAMPLE THAT IS PRODUCED WITHOUT DEFECTS AND WITH SUPPORT. THE DISTINCTIVE FEATURE OF THIS DEVICE IS THAT IT WORKS VERY PROFESSIONALLY WITHOUT CAUSING PAINT BURNS.

- SUITABLE FOR ALUMINUM SHEETS
- ABILITY TO ADJUST THE REQUIRED TEMPERATURE
- HAS AN AUTOMATIC MAGNETIC SYSTEM MODULE
- NO PAINT BURNS
- PERFORM MAGNETICALLY
- SIMPLE AND EFFICIENT PERFORMANCE

SETS OF REPAIRING RODS

EXPLANATIONS

THE MAIN DIFFERENCE BETWEEN TRADITIONAL AND MODERN REPAIRING IS USING NEW TOOLS SUCH AS PDR RODS. PDR RODS CONSIST OF SOME SPRING RODS WITH UNIQUE SHAPES, BENDS AND TIPS, EACH OF WHICH IS CONNECTED TO DIFFERENT PARTS OF THE CAR. THESE REPAIRING RODS ARE A NEW TOOL FOR PAINTLESS DENT REPAIRING, WHICH BRINGS YOU LESS PHYSICAL DAMAGE IN ADDITION TO HIGHER QUALITY. MODERN REPAIRING HAS SUITABLE AND NEW TOOLS FOR POLISHING AND REPAIRING OUT OF REACH PARTS SUCH AS DOUBLE PARTS OF THE CAR AND DOORS WITHOUT OPENING DIFFERENT PARTS OF THE DOOR AND THE VEHICLE WITH MINOR

PIECE ROD-64

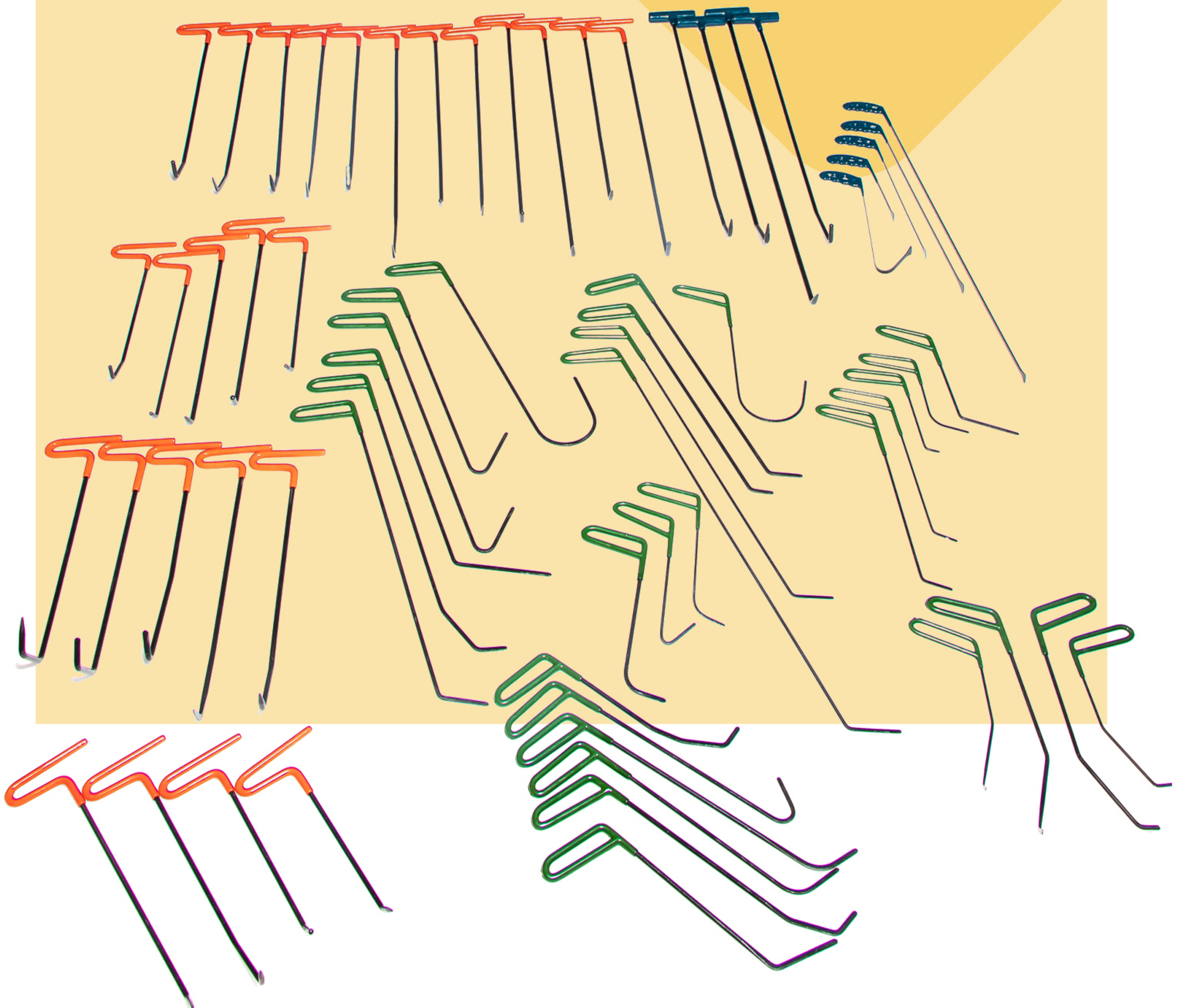

AMERICAN 60-PIECE ROD

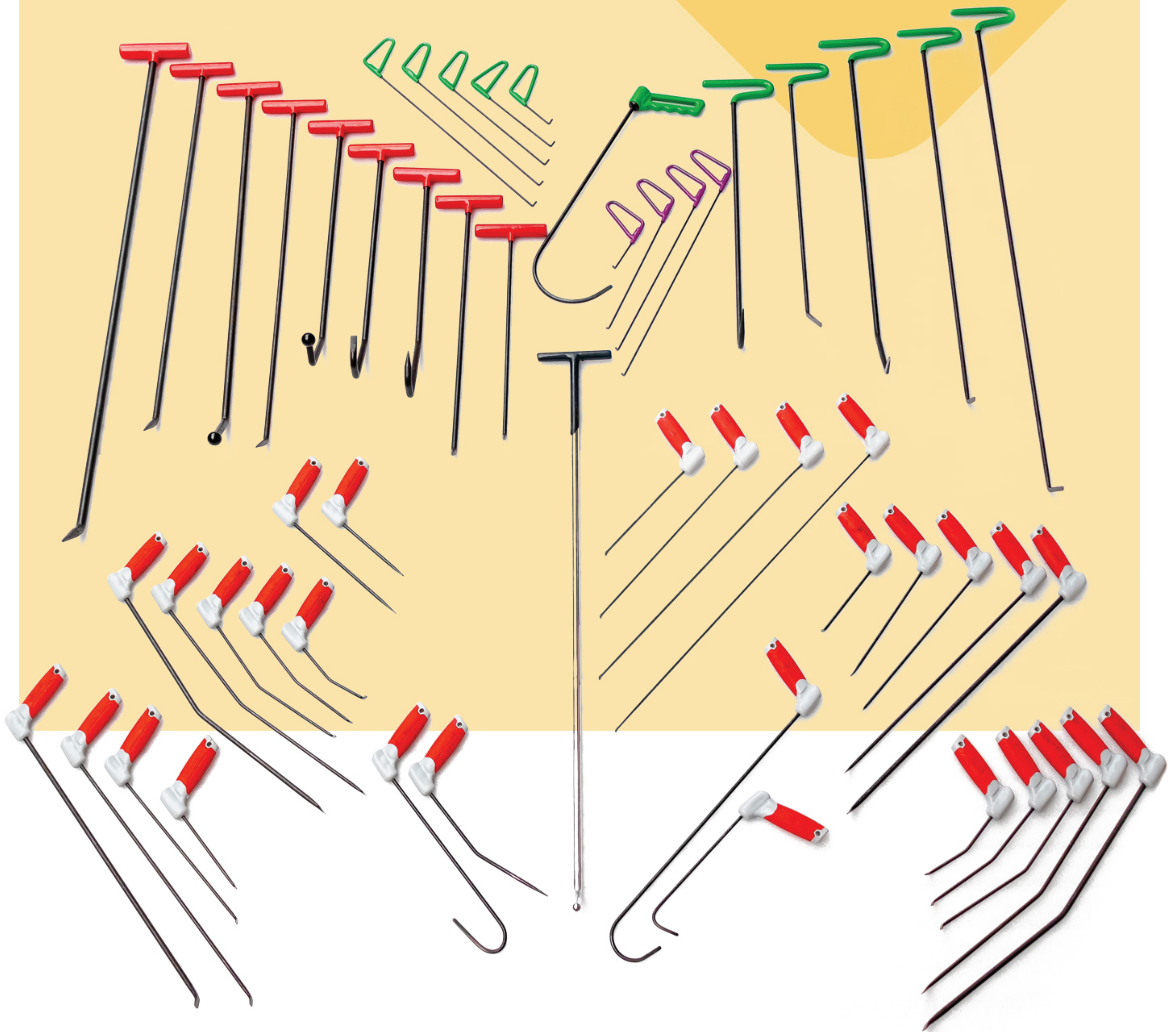

TURKISH 55-PIECE ROD

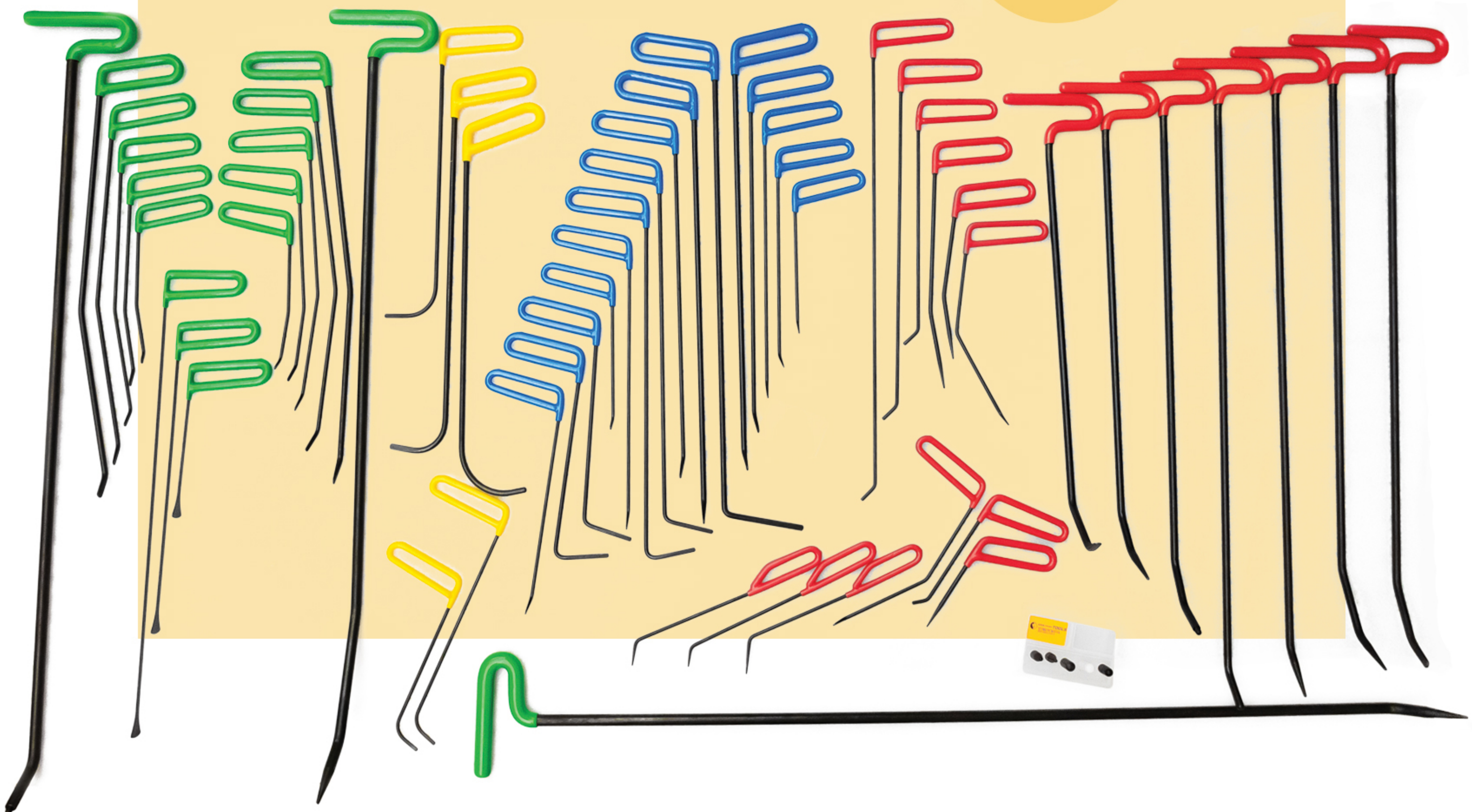

BAR TABLE

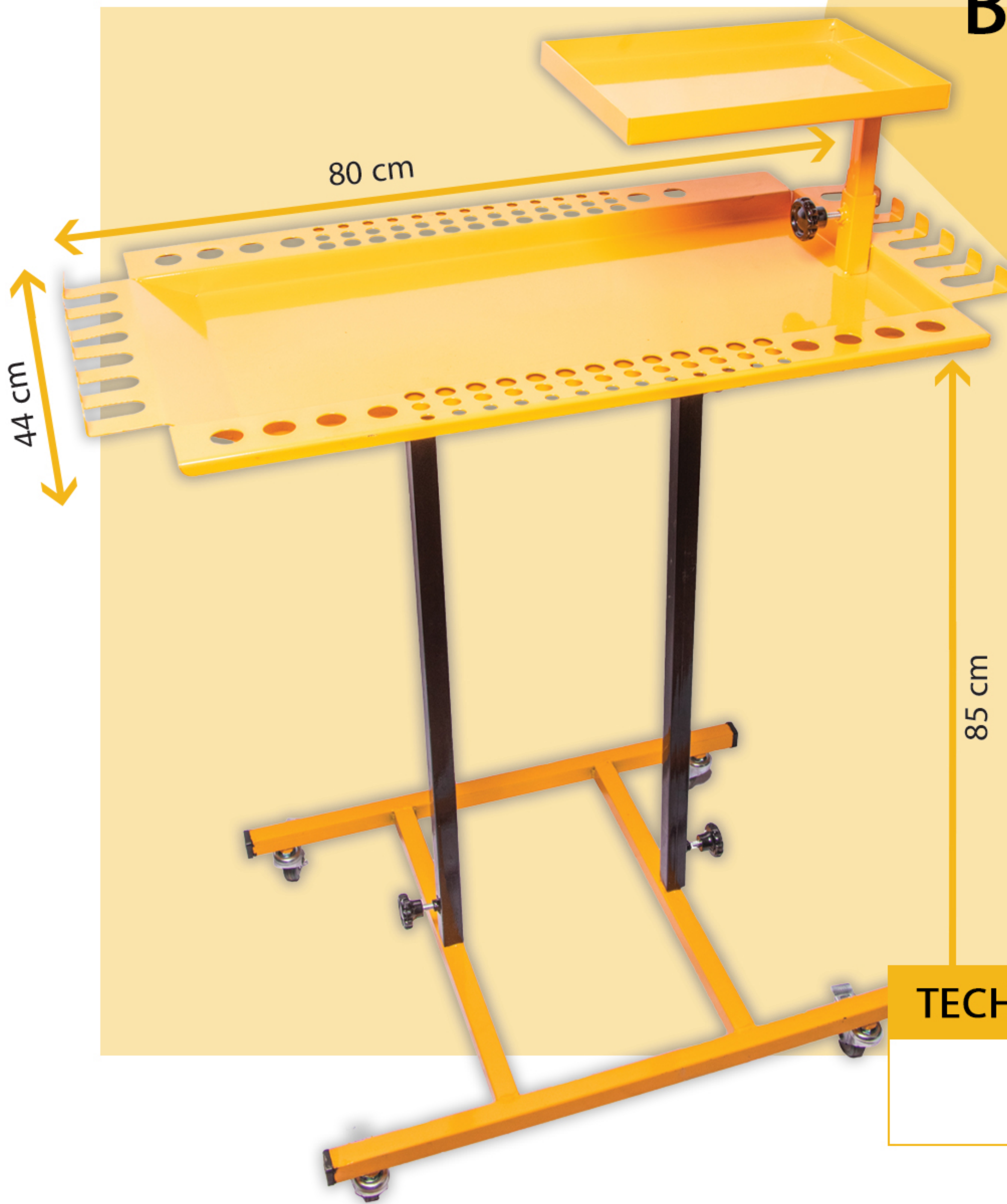

TECHNICAL SPECIFICATIONS

WEIGHT 15 KG



EXPLANATIONS

- ◆ SUITABLE FOR PLACING REPAIRING RODS.
- ◆ PREVENTS IRREGULARITIES AND DISPLACEMENT OF BARS .
- ◆ EASY TO MOVE
- ◆ EQUIPPED WITH MOVEABLE WHEELS FOR MOVING

ACCORDION WORK TABLE

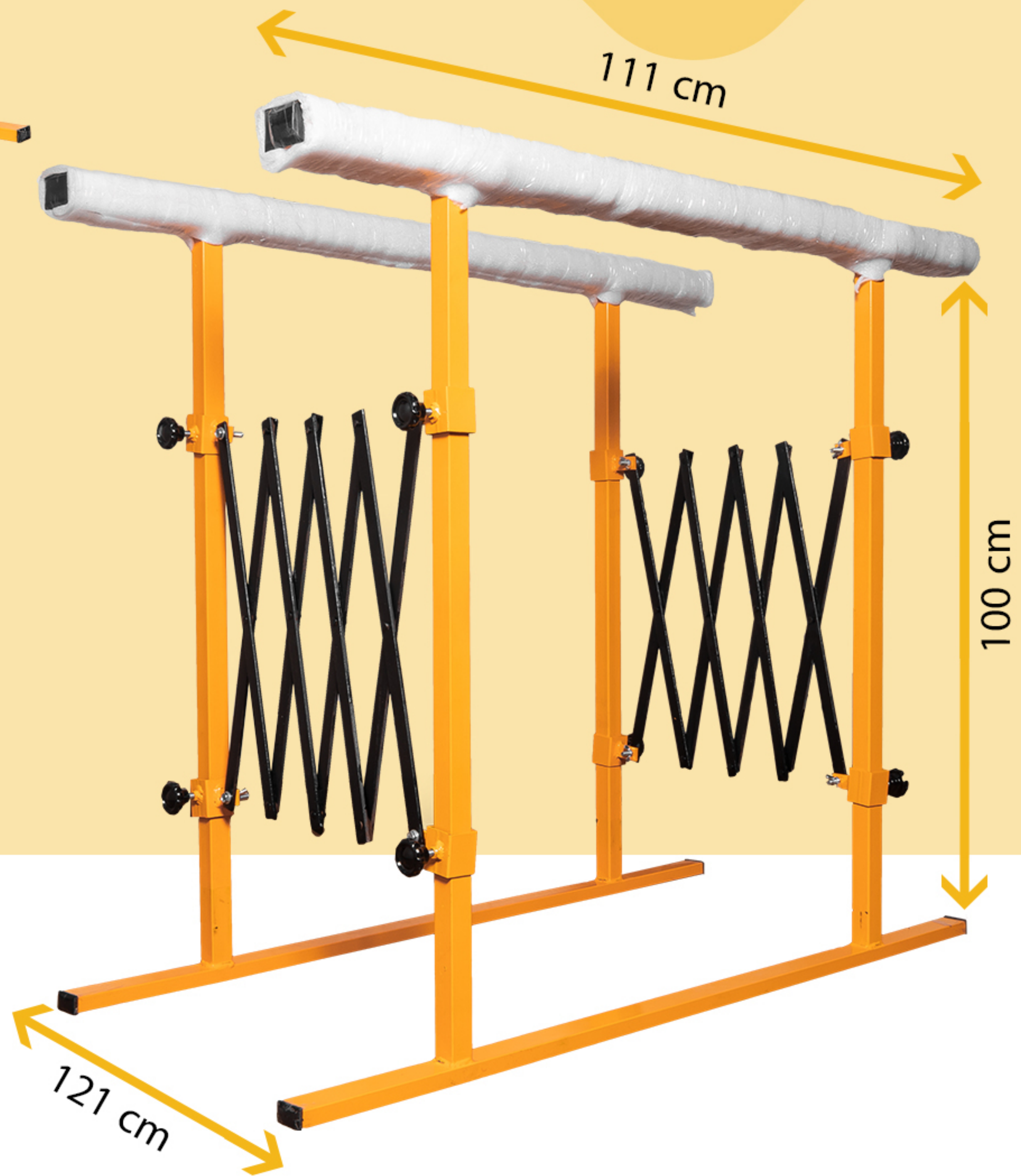



EXPLANATIONS

- ◆ THIS IS SUITABLE FOR HOLDING CAR PARTS SUCH AS HOOD, DOOR, ETC. FOR REPAIRING.

- ◆ ONE OF THE ADVANTAGES OF THIS TABLE IS ITS ABILITY TO FOLD AND UNFOLD, WHICH IS SUITABLE FOR SMALL PLACES.

ACCORDION WORK TABLE

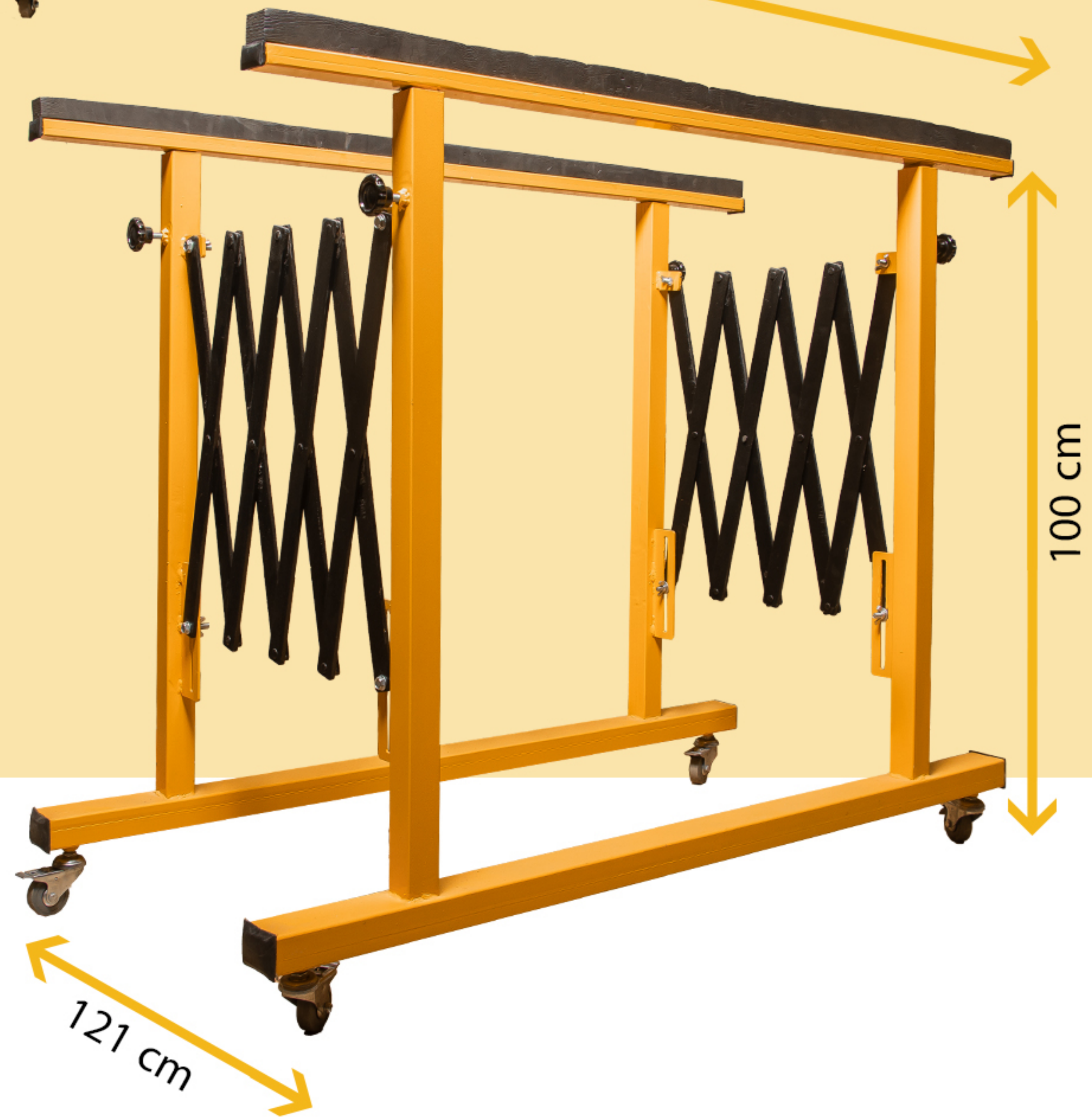
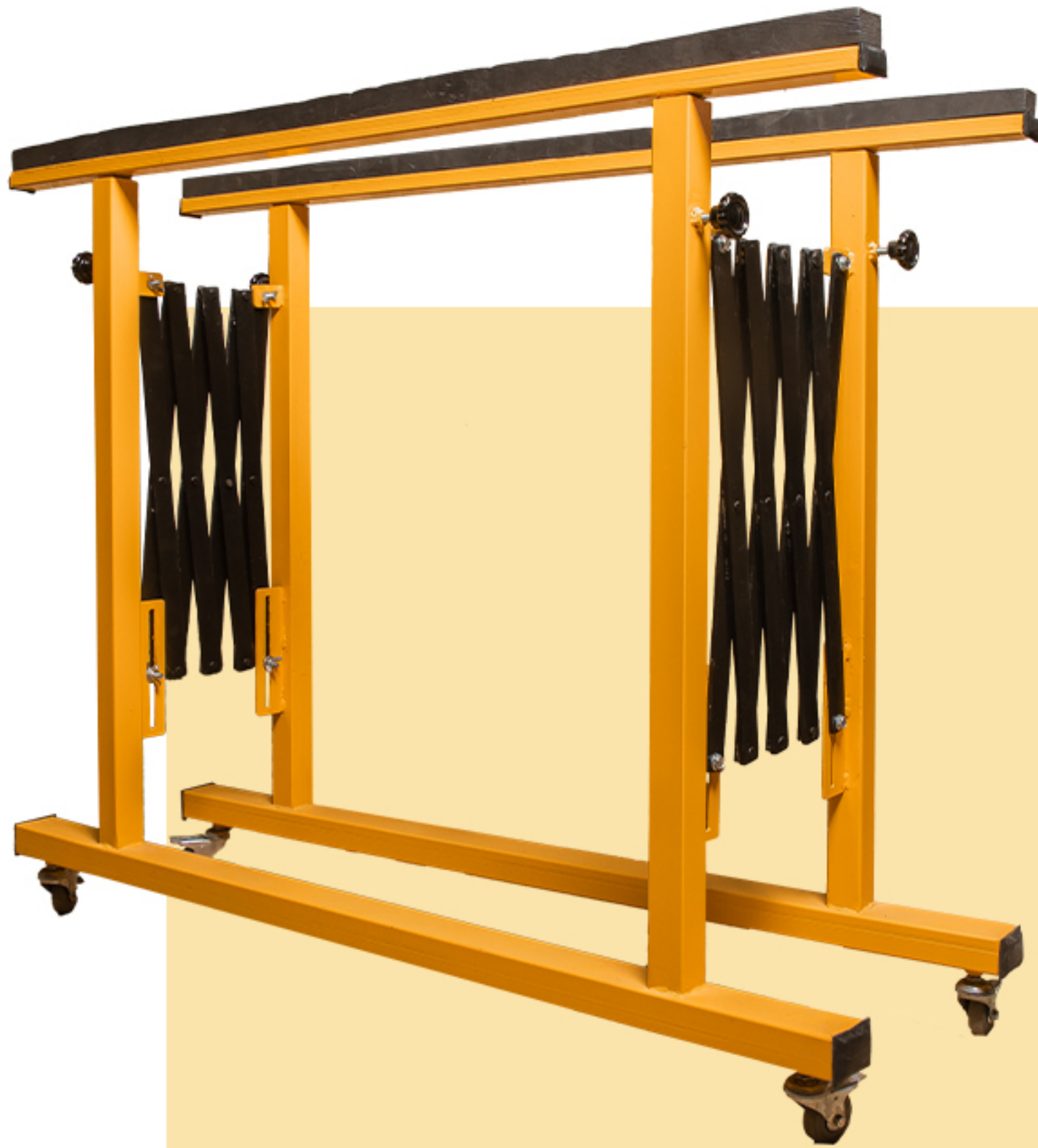



EXPLANATIONS

- ◆ THIS IS SUITABLE FOR HOLDING CAR PARTS SUCH AS HOOD, DOOR, ETC. FOR REPAIRING.
- ◆ ONE OF THE ADVANTAGES OF THIS TABLE IS ITS ABILITY TO FOLD AND UNFOLD, WHICH IS SUITABLE FOR SMALL PLACES.
- ◆ ITS SO EASY TO MOVE AROUND YOUR GRAGE.

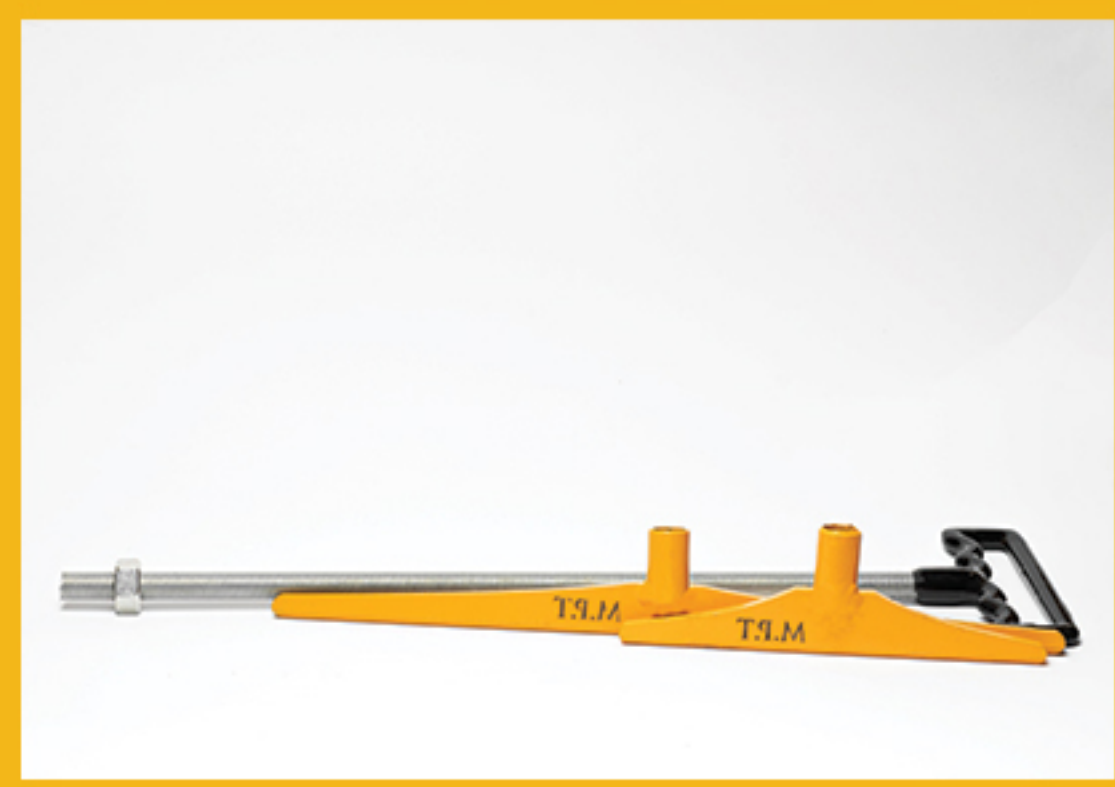

LINEART

IT CAN BE USED AS AN AX TO REMOVE DENTS AND TINY LINES. THIS TOOL IS USED INSTEAD OF AN AX, AND BECAUSE IT WORKS IN SCREWING WAY, IT IS ABLE TO CUT THE LINES TO THE DESIRED SIZE. IT DOES NOT BREAK THE PAINT AND IS MORE ACCURATE.



METAL DENT PULLER CLAMP

A SUITABLE TOOL FOR DENTS AND HAIL DAMAGE ON THE BODY OF THE CAR WITH THE ABILITY TO ADJUST THE HEIGHT ACCORDING TO THE GLUE TABS THAT ARE PLACED INSIDE.



DENT PULLER CLAMP

A SUITABLE TOOL FOR DENTS AND HAIL DAMAGE ON THE BODY OF THE CAR WITH THE ABILITY TO ADJUST THE HEIGHT ACCORDING TO THE GLUE TABS THAT ARE PLACED INSIDE. THIS SET COMES WITH 24 GLUE TABS.



SHOVEL REMOVE GLUE

CLEANS THE GLUE AND WAXES ON THE BODY AND THE DOOR. AS IT IS LONG AND THIN, IT IS ALSO VERY SUITABLE FOR REMOVING WAXES FROM THE BACK OF THE DOUBLE PARTS OF THE CAR, WHICH ARE OUT OF REACH, IT CAN ALSO BE USED AS A LARGE TOOL FOR REMOVING STREAKS.



TEFLON PIN

IT REMOVES SPOTS AND STREAKS ON THE BODY OF THE CAR WITHOUT DAMAGING TO THE CAR BODY PAINT.



COLD GLUE

SUITABLE FOR SHAPING ALL PARTS OF THE CAR. WHETHER THEY HAVE BEEN HIT LIGHTLY OR SEVERELY. ONE OF THE ADVANTAGES OF THIS PRODUCT IS THAT IT CAN BE SHAPED AS DESIRED.

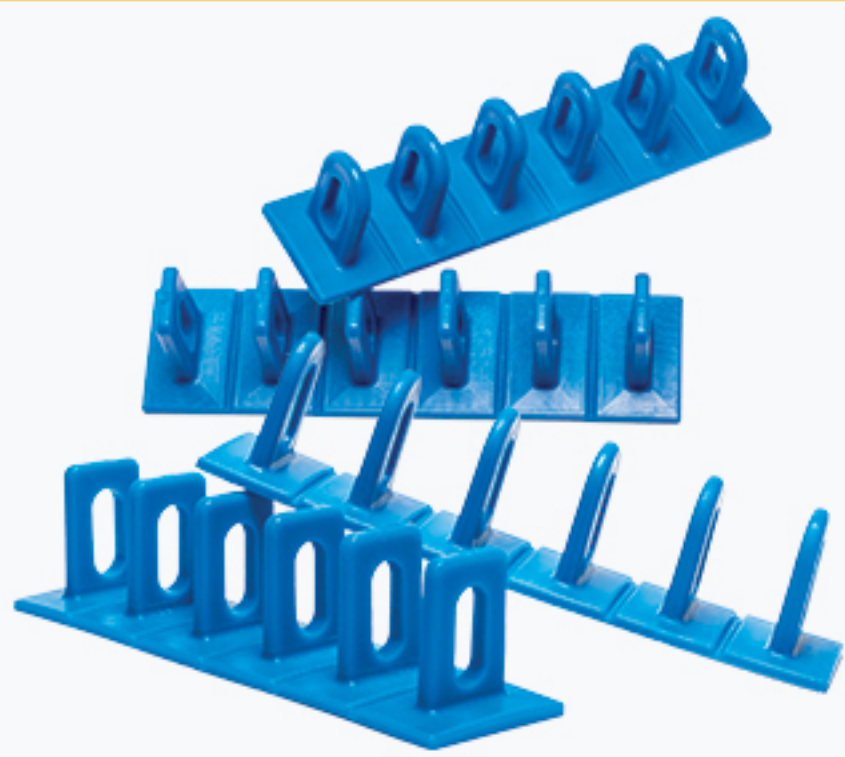

MULTI GLUE TAB

SUITABLE FOR TAILGATE OF SOME KINDS OF CAR SUCH AS DENA OR L90, WHICH HAS NO PLACE TO PASS THE ROD TO REMOVE DENTS OR HAIL DAMAGES.



PDR HAMMER

SUITABLE FOR PDR TASKS AND REMOVING STREAKS WITH TWO HEADS



**REMOVAL HAIL
HAMMER**

THIS PRODUCT IS USED TO PERFORM PRECISE WORK IN THE LAST STAGE OF WORK AND HAS A WOODEN HANDLE AND IS LIGHTER.



BLENDING HAMMER

SUITABLE TOOL FOR ALL CAR SHEETS SUCH AS IRON AND ALUMINUM. IT REMOVES STREAKS AND THEN SMOOTHIES THE ENTIRE SURFACE.



DENT DING HAMMER

THIS PRODUCT IS DUAL-PURPOSE AND ALLOWS THE BODY-REPAIR-MAN TO REMOVE THE CREATED STREAKS AND SPOTS ON THE SURFACE AT THE SAME TIME.



DENT DING HAMMER

THIS IS A DOUBLE-SIDED HAMMER ITS WIDE HEAD IS FOR LARGE STREAKS. THIS HAMMER HAS REPLACEMENT HEADS FOR SMALL STREAKS WITH SHORT AND LONG DISTANCES.



**TURKISH REMOVAL
HAIL HAMMER**

THIS HAMMER IS SUITABLE FOR REMOVING SPOTS. IT IS USED AS A SPOT REMOVER WHEN THE SPOT OR STREAK IS NOT AVAILABLE, OR POINTS SUCH AS FENDERS OF SUV THAT SPOTS OR STREAKS CAN BE SEEN FROM A DISTANCE.



**SLIDE HAMMER
T BAR PULLER**

IT IS USED IN ORDER TO REPAIR HAIL DENT DAMAGES ALSO SHAPING THE SURFACE WITH THE COLD GLUE.



KNOCKDOWN PADDLE

THIS TOOL CAN ALSO BE USED AS A HAMMER OR HANDLE TO HIT THE REMOVAL HAIL HAMMER.



DENT PULL LEVER BAR

SUITABLE TOOL FOR PULLING THE ROCKER PANE AND PILLAR TRIM USING ZIGZAG WIRE AND WASHER MANUALLY, WHICH ALLOWS THE BODY-REPAIR-MAN TO REMOVE THE EXISTING STREAKS WITH A HAMMER WHILE REPAIRING.



**PDR REMOVAL
HAIL HAMMER**

THIS HAMMER IS TWO-SIDED AND ITS WIDE HEAD IS USED TO REMOVE LARGE STREAKS. IT HAS A HEAD FOR REMOVING SPOTS AND A SMALL WOODEN HANDLE.



DUAL-PURPOSE PADDLE

THIS PADDLE HAS A RUBBER COATING THAT MAKES LESS NOISE WHEN DEALING WITH REMOVING DENTS, AND ITS UNIQUE DESIGN PREVENTS IT FROM COLLIDING WITH THE HAND AND IS EASY TO WORK WITH.



**BIG METAL
KNOCKDOWN PEN**

IT IS USED TO REMOVE THE STREAKS ON THE CAR BODY WITHOUT DAMAGING THE PAINT AND THE FINAL SURFACE.



**SMALL METAL
KNOCKDOWN PEN**

IT HAS A LIGHTER AND SMALLER DESIGN THAN OTHER METAL KNOCKDOWN PENS.



**TEFLON PDR
KNOCKDOWN**

IT IS USED TO REMOVE SPOTS AND STREAKS ON THE CAR BODY WITHOUT DAMAGING THE PAINT.



**ROUND TIP TEFLON
PDR KNOCKDOWN**

IT IS USED TO REMOVE SPOTS AND STREAKS ON THE CAR BODY WITHOUT DAMAGING THE PAINT AND ITS IVORY.



**METAL PDR
KNOCKDOWN**

THIS KNOCKDOWN IS SUITABLE FOR REMOVING SMALL SPOTS AND STREAKS.



**PDR KNOCKDOWN
WITH 8 HEADS**

DUE TO THE INTERCHANGEABLE HEADS, THIS KNOCKDOWN HAS THE ABILITY TO REPAIR ALL KINDS OF SPOTS AND STREAKS WITHOUT DAMAGING THE PAINT.



**WOODEN PDR
KNOCKDOWN**

THIS KNOCKDOWN IS LIGHT AND BECAUSE IT IS WOODEN, IT PREVENTS THE REFLECTION OF LIGHT, AND IT HAS BOTH ROUND AND TAPERED TIP.



STEEL KNOCKDOWN

THIS KNOCKDOWN IS SUITABLE FOR REMOVING ALL KINDS OF STREAKS AND SPOTS, WHICH HAS A HEAVIER WEIGHT THAN SIMILAR KNOCKDOWNS.



**METAL KNOCKDOWN
WITH TURKISH DESIGN**

THIS KNOCKDOWN HAS A TAPERED AND SHARP TIP TO REMOVE STREAKS AND SMALL DOTS ON THE EDGE OF THE DOOR AND HOOD.



EDGED LEVER

A SUITABLE TOOL FOR ADJUSTING THE EDGES, SUCH AS THE EDGES OF THE DOOR OF THE HOOD, ETC



TURKISH KNOCKDOWN

IT IS USED TO REMOVE SPOTS AND STREAKS ON THE CAR BODY WITHOUT DAMAGING THE PAINT AND ITS IVORY.



NO-ROLL KNOCKDOWN

IT IS USED TO REMOVE SPOTS AND STREAKS ON THE CAR BODY WITHOUT DAMAGING THE PAINT OF FINAL POLISH AND ALSO IT IS USED TO REMOVE TINY STREAKS AND SPOTS.



WRIST KNOCKDOWN

IT MAKES THE REPAIRING PROCESS EASY; IT HAS DIFFERENT HEADS TO REMOVE DIFFERENT TYPES OF SPOTS. ITS ADVANTAGE OVER OTHER SIMILAR TOOLS IS THAT IT DOES NOT CAST A SHADOW ON THE WORK.



PDR WIDE WHALE TAIL SET

THIS SET IS SUITABLE FOR REPAIRING THE POINTS WHERE THE GLUE AROUND THE FENDER OR THE CAR DOUBLE PREVENT THE RODS FROM REACHING THOSE POINTS. THESE RODS ARE DESIGNED WITH FLEXIBILITY AND SPECIAL HEADS AND WILL HELP YOU TO WORK EASIER. USES OF THIS SET ARE MOSTLY FOR HOOD, ROOF AND DOUBLE PARTS OF A CAR.



TURKISH KNOCKDOWN

IT IS USED TO REMOVE SPOTS AND STREAKS ON THE CAR BODY WITHOUT DAMAGING THE PAINT AND ITS IVORY.



NO-ROLL KNOCKDOWN

IT IS USED TO REMOVE SPOTS AND STREAKS ON THE CAR BODY WITHOUT DAMAGING THE PAINT OF FINAL POLISH AND ALSO IT IS USED TO REMOVE TINY STREAKS AND SPOTS.



WRIST KNOCKDOWN

IT MAKES THE REPAIRING PROCESS EASY; IT HAS DIFFERENT HEADS TO REMOVE DIFFERENT TYPES OF SPOTS. ITS ADVANTAGE OVER OTHER SIMILAR TOOLS IS THAT IT DOES NOT CAST A SHADOW ON THE WORK.



PDR WIDE WHALE TAIL SET

THIS SET IS SUITABLE FOR REPAIRING THE POINTS WHERE THE GLUE AROUND THE FENDER OR THE CAR DOUBLE PREVENT THE RODS FROM REACHING THOSE POINTS. THESE RODS ARE DESIGNED WITH FLEXIBILITY AND SPECIAL HEADS AND WILL HELP YOU TO WORK EASIER. USES OF THIS SET ARE MOSTLY FOR HOOD, ROOF AND DOUBLE PARTS OF A CAR.



VEIN EMBED

THIS PRODUCT TO PREVENT HOLES AND BITES ON THE CAR BODY BY RODS AND SLATS USED DURING WORK.



PDR HOLE PLUGS KIT

IT PREVENTS TO MAKE HOLES AND SPOTS ON THE BODY OF THE CAR BY RODS AND KNOCKDOWNS.



TECHNO SAF PDR SET

THIS SET INCLUDES A SLIDE HAMMER, AN EIGHT-HEAD HAIL HAMMER, TWENTY-FOUR GLUE TABS, A HOT MELT GLUE GUN WITH TEN HOT GLUES, ALL OF WHICH ARE USED FOR PDR AND INITIAL SHAPING.



8 HEADS SERIES SET

WITH THIS SET YOU WILL HAVE THREAD HEADS FOR PDF RODS AND ONE EIGHT-HEAD ROD, AND TEFLON HEADS SUITABLE FOR REPAIRING LINEAR AND BALL STREAKS AND SUITABLE FOR REMOVING HAIL DENTS DAMAGES.



VEIN EMBED

THIS PRODUCT TO PREVENT HOLES AND BITES ON THE CAR BODY BY RODS AND SLATS USED DURING WORK.



PDR HOLE PLUGS KIT

IT PREVENTS TO MAKE HOLES AND SPOTS ON THE BODY OF THE CAR BY RODS AND KNOCKDOWNS.



TECHNO SAF PDR SET

THIS SET INCLUDES A SLIDE HAMMER, AN EIGHT-HEAD HAIL HAMMER, TWENTY-FOUR GLUE TABS, A HOT MELT GLUE GUN WITH TEN HOT GLUES, ALL OF WHICH ARE USED FOR PDR AND INITIAL SHAPING.



8 HEADS SERIES SET

WITH THIS SET YOU WILL HAVE THREAD HEADS FOR PDF RODS AND ONE EIGHT-HEAD ROD, AND TEFLON HEADS SUITABLE FOR REPAIRING LINEAR AND BALL STREAKS AND SUITABLE FOR REMOVING HAIL DENTS DAMAGES.



COLD GLUE AND METAL PDR TABS

THIS SET HAS A PACKAGE OF 150 G OF COLD GLUE AND FOUR METAL PDR TABS FOR PAINTLESS DENT REPAIR AND PROFESSIONAL INITIAL SHAPING OF THE WORK AND IT IS A SUITABLE ALTERNATIVE FOR AIR SUCTION.



A SET OF 150 PDR TABS

BY USING THIS PRODUCT IN CASES OF HAIL DENT DAMAGE, THE CAR BODY CAN BE EASILY REPAIRED BY USING IT. THESE SETS ARE OFFERED IN PACKS OF 50, 100 AND 150.



A SET OF 100 PDR TABS

BY USING THIS PRODUCT IN CASES OF HAIL DENT DAMAGE, THE CAR BODY CAN BE EASILY REPAIRED BY USING IT. THESE SETS ARE OFFERED IN PACKS OF 50, 100 AND 150.



WHEEL SUPPORT FOR PDR RODS

THIS PRODUCT IS MOUNTED ON THE CAR TIRES AND YOU CAN EASILY SMOOTH AND REPAIR THE CAR FENDERS WITHOUT SLIPPING.



IT'S THE TECHNO-SAF PRODUCT THAT IS USED FOR EASE OF WORK WHEN MEASURING DISTANCE AND DRAWING A LINE AROUND THE FENDER, WHICH IS USED TO FACILITATE BODY REPAIRING WITH A BAR.

DRAWING COMPASS



TEFLON BOARD

THIS PRODUCT IS TO PROTECT THE GLASS FROM BEING BROKEN BY PDR RODS.



GLUE REMOVER SOLUTION

A SUITABLE SUBSTANCE TO REPLACE THINNER OR ACETONE. THIS MATERIAL IS COLORLESS AND ANTI-ALLERGIC, AND THE GLUE CAN BE EASILY REMOVED FROM THE CAR BODY WITHOUT ANY WORRIES ABOUT PAINT DISTORTION.

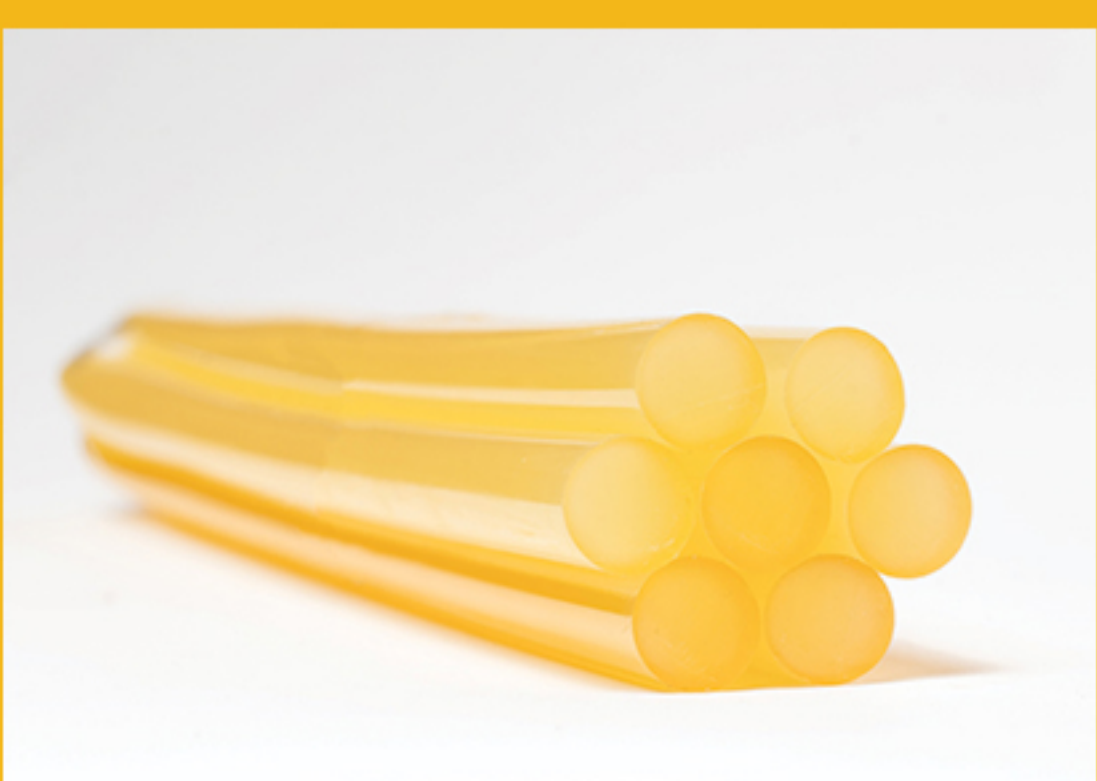

WHITE HOT GLUE

SUITABLE PRODUCT FOR REMOVING CAR HAIL AND SMALL DENTS WHICH IS DONE FOR EACH CAR USING ITS OWN TOOLS.



WORK GLOVES

THIS GLOVE PROTECTS THE HAND WHEN USING THE BAR., AND PREVENTS SLIPPING OF THE ROD IN BODY-REPAIRMAN'S HAND.



PDR DISHCLOTH

THIS IS USED TO CLEAN THE SURFACE . IT HAS NANO-FIBER AND DOES NOT DAMAGE THE PAINT AND THE SURFACE.



AIR ANGLE GRINDER SET

IT OPENS THE DOUBLE PARTS; IT HAS A HIGH LEVEL OF SAFETY AND IT WILL BE CUT OFF AUTOMATICALLY IF THE DESIRED TOOL IS STUCK.



ZIG ZAG WIRE

THIS TOOL IS USED TO REMOVE DENTS AROUND THE FENDERS, ROCKER PANEL, AND PILLAR TRIMS ALONG THE HOOD



ROPE RATCHET CLAMP

THIS IS A TOOL THAT IS USED WITH A HOOD PROP TO HOLD THE HOOD OR TAILGATE UP



HOOD PROP

A SUITABLE TOOL TO HOLDING HOOD OR TAILGATE UP.



PDR GLASSES

WEARING THESE GLASSES BRINGS COMFORT TO THE EYES WHEN USING THE PDR LAMP BOARD, PREVENTS EYE IRRITATION, TEARS AND REDNESS, IT ALSO PREVENTS HEADACHES CAUSED BY THE LAMP BOARD.



SIMPLE DOOR LOCK

IT'S A SUITABLE TOOL TO BE REPLACED BY LOCKING PLIERS IN ORDER TO FIX DOORS.



METAL SHOVEL

IT IS USED TO CLEAN THE SURFACE AND REMOVE THE GLUE AND WAXES.



PUMP WEDGE

SUITABLE TOOL FOR OPENING SEAMS AND CRACKS IN GLASS AND DOUBLE PARTS THAT A BAR CANNOT BE USED, AND WITHOUT DAMAGING THE BODY OR THE DESIRED LOCATION, IT CAN TEMPORARILY OPEN THE GAPS AND BE A WAY TO PASS THE RODS AND PERFORM REPAIRING OPERATIONS.



PDR STRAP

A SUITABLE TOOL FOR USING THE BAR ACTS AS A LEVER WHEN THE REPAIRING IS DONE FROM THE ROOF OF THE CAR.



TROWEL

THIS PRODUCT IS USED TO REMOVE THE STREAKS ON THE CAR BODY AND IT CAN BE USED INSTEAD OF THE STEEL SUPPORT HAMMER KNOCKDOWN SLOPE. UNLIKE THE IT, THE TROWEL HAS A SPRINGY PROPERTY AND LEAVES NO TRACE ON THE BODY.



STEP DRILL

IT CAN BE USED IN CASES WHERE THE ROD DOES NOT HAVE ROOM TO PASS, SUCH AS DOUBLE PARTS, YOU CAN USE THIS PRODUCT TO MAKE A HOLE IN THE FORM OF A FABRIC AND REPAIR IT WITH A ROD.



MULTI PDR TAB

THIS SERIES IS SUITABLE FOR REMOVING OF DOUBLE PARTS OF A CAR AND ROCKER PANEL THAT NEED STRONGER HIT.



PULLING BRIDGE FOR HAIL DAMAGE

THIS PULLER IS SUITABLE FOR REMOVING DENTS ON PILLAR TRIM AND DOUBLE PLACES; IT HAS VARIABLE BASE SO, FITS BETTER, AND BY SCREWING THE TOP SCREW ON THE TOOLS, THE DENTS RISE EASILY AND SLOWLY, AND IN THIS SITUATION SMALL STREAKS AND HOLES AROUND THE DENTS CAN BE REMOVED.



HEAT GUN

THIS DEVICE IS SUITABLE FOR HEATING THE WORK SURFACE AND PREVENTING PAINT CRACKING.



**HOT MELT GLUE
GUN 500W**

A SUITABLE TOOL FOR MELTING HOT GLUE FOR GLUE TABS AND OTHER PULLER DENT TOOLS THAT NEED GLUE.ITS CHARGING MELTING.



HOT MELT GLUE GUN

A SUITABLE TOOL FOR MELTING HOT GLUE FOR GLUE TABS AND OTHER PULLER DENT TOOLS THAT NEED GLUE.



**PDR RUBBER
HOLE PLUGS KIT**

IT IS USED ON HEADS OF PDR RODS AND KNOCKDOWNS TO REPAIR LARGER SPOTS AND STREAKS.



PULLER NET

THIS PRODUCT IS A SUITABLE TOOL FOR PULLING AND FORMING ALL KINDS OF BODY SHEETS BY LEVER BLOCK.



NEW TOOL OF PAINLESS DENT REPAIR



Managers and Sales Experts

۰۳۵ - ۹۱۰ ۹۱۰ ۰۹



@MPTTOOLS.IR

@MPTTOOLS.CO

@SAFKARIYAZD

@TECHNOSAF

@IRAN.PDR